

# KRATOS | GENERAL MICROWAVE Microwave Electronics Division

## MICROWAVE CONTROL COMPONENTS

Kratos General Microwave is a world leader in the design and production of Microwave Control Components. The Control Components product line includes a wide range of catalog Attenuators, IQ Vector Modulators, Phase Shifters, Limiters, Switches, Switch Matrices and Switch Filter Banks. In addition to the catalog COTS products, General Microwave provides custom made Control Components for a wide range of applications such as: EW Systems, Simulators, Test Equipment and Medical Instruments.

### Attenuators

Kratos General Microwave PIN diode attenuators cover frequencies up to 40 GHz and were designed with various topologies, each of which has been selected to optimize certain performance characteristics. This includes Analog Attenuators, Switch Bit Attenuators and Phase Invariant Attenuators. Most designs are available with either analog or digital control and operate over octave or multi-octave bands with high or moderate switching speed characteristics. Special emphasis is given to ensure High Repeatability and Monotonicity.

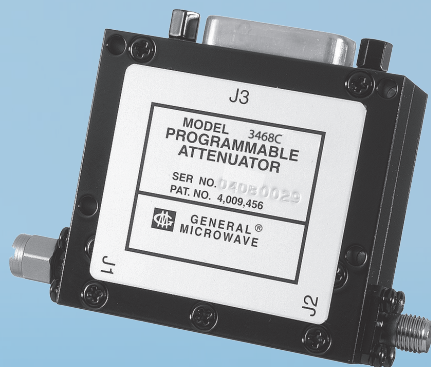

2 to 18 GHz ATTENUATOR

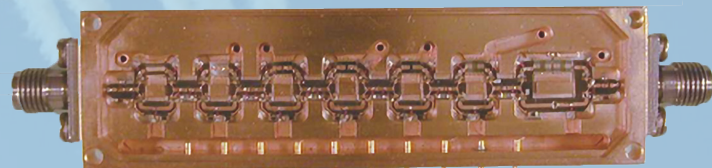

SWITCH BIT ATTENUATOR

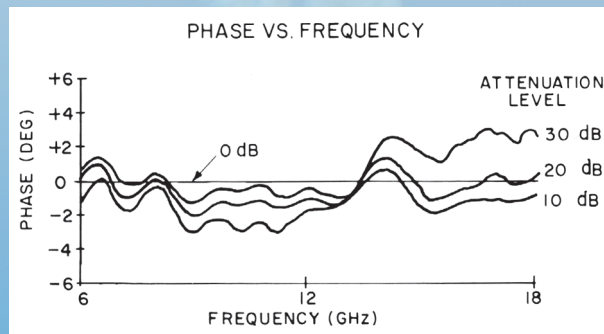

PHASE INVARIANT ATTENUATOR

## Switches

KRATOS General Microwave offers a wide range of microwave PIN diode switches up to 40 GHz. The product line includes a wide range of switches from SPST to multi throw switches of SP16T, as well as low and high Power switches.

In addition to the range of catalog switches, KRATOS General Microwave offers custom designed switches per specific requirements, for military and for non military applications.



0.1 to 40 GHz SPDT SWITCH

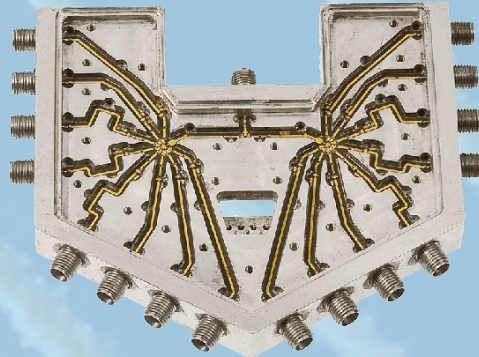

SP16T SWITCH

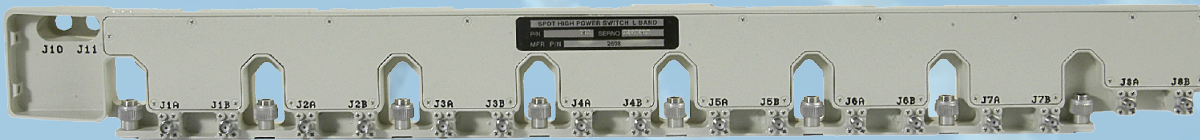

0.5KW SPDT SWITCH ARRAY

## Limiters

KRATOS General Microwave offers PIN diode-based limiters, supporting up to 600 watts of pulsed power. The limiters can be supplied in various configurations: connectorized, drop-in or with field-removable connectors. The limiters can be supplied as stand alone limiters, or as integrated modules that include the limiter and a control component such as a switch or attenuator.

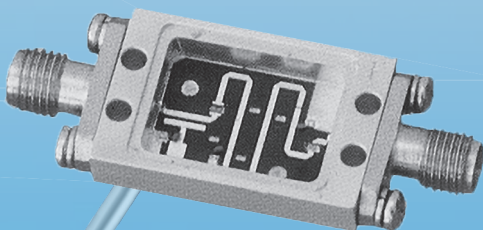

HIGH POWER LIMITER

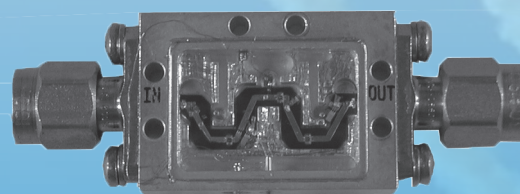

SWITCH LIMITER



# KRATOS | GENERAL MICROWAVE Microwave Electronics Division

## Phase Shifters

KRATOS General Microwave offers a wide range of catalog broadband microwave phase shifters up to 40 GHz. These microwave and RF Phase Shifters are available in several different topologies that allow the system designer to choose among various performance characteristics that best suit his system needs. In addition to the catalog products, Kratos General Microwave offers custom design products to meet customer's specific applications.



**18 to 40 GHz  
PHASE SHIFTER**

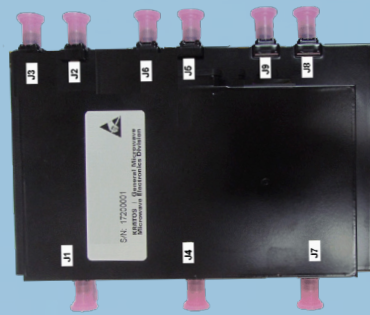

**CUSTOM HIGH POWER  
PHASE SHIFTER**



**OCTAVE BAND  
PHASE SHIFTER**

## IQ Vector Modulator

KRATOS General Microwave offers a wide range of catalog broadband microwave and RF IQ Vector Modulators which cover frequencies up to 40 GHz. These microwave and RF IQ Vector Modulators are available in several different topologies that allow the designer to choose among various performance characteristics that best suit his system needs. In addition to catalog products, there are numerous special design products, which Kratos General Microwave has utilized in custom applications.

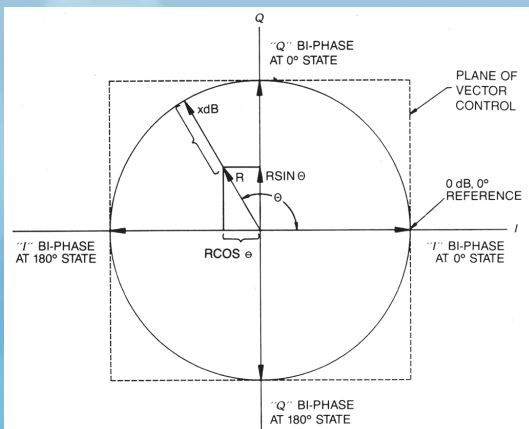

**VECTOR MODULATOR**



**OCTAVE BAND IQ VEC-  
TOR MODULATORS**

## Switch Filter Banks

Kratos General Microwave provides various types of switched filter banks. These are customized products designed to meet specific customer requirements. The main features of this product line are:

- Fast Switching
- Low Loss
- Temperature Stability

Various filter technologies can be used such as:

- Cavity Compline
- Lumped Elements
- Printed Filters

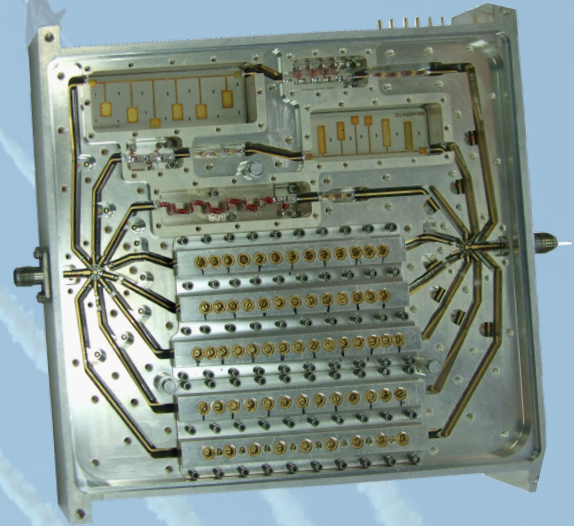

**MULTI TECHNOLOGY FILTER BANK**

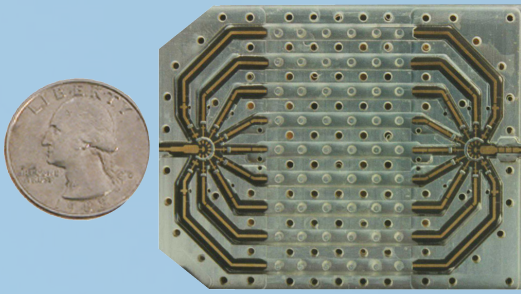

**9 CHANNEL FILTER BANK**

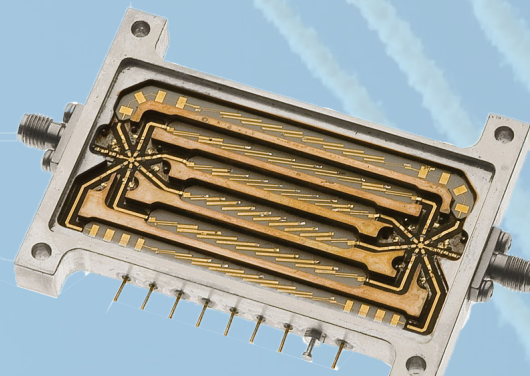

**6 CHANNEL FILTER BANK**

**KRATOS | GENERAL MICROWAVE**  
Microwave Electronics Division

### ISRAEL

**JERUSALEM SITE:**

20 Pierre Koenig

Jerusalem 9153102

Tel: +972-2-568-9444

kratos-gmi@kratos-med.com

### ISRAEL

**EYAL SITE:**

Kibbutz Eyal

D.N.Hasharon Hatichon 4584000

Tel: +972-9-749-9100

kratos-eyal@kratos-med.com

### USA

**NEW YORK SITE:**

227A Michael Drive

Syosset, New York 11791

Tel: +1-516-802-0900

kratos-gmc@kratosdefense.com

**www.kratosmed.com**